

Sélection de meubles  
et supports pour écrans plats





## Smile

Ref. **1085960** GENCOD 318528 035268 5

**XL** 40"-75"  
102-190cm



60 KG

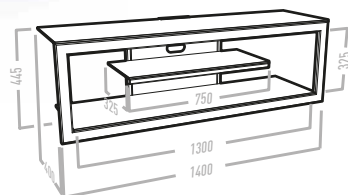

- Plateau supérieur en verre trempé noir 8 mm
- Etagère et plateau inférieur en verre trempé sérigraphié noir 6 mm
- Structure en acier ; peinture epoxy texturée, satinée blanche
- Verrouillage du plateau supérieur
- Ouvertures et colonne passe-câbles à l'arrière
- Montage en 5 mn sans outil

## Cub **1600**

Ref. **1043001** GENCOD 318528 035266 1

**XL** 40"-75"  
102-190cm



100 KG

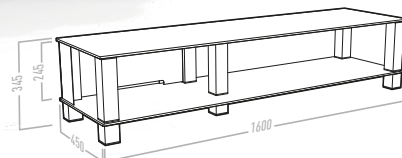

- Plateaux en verre trempé noir 10 mm
- Pieds carrés en aluminium, collage UV des pieds pour un effet par transparence
- Peinture époxy texturée, satinée noire
- Ouvertures passe-câbles à l'arrière

Will



Et votre écran devient mobile !



### CARACTÉRISTIQUES TECHNIQUES

- Réglage de l'écran en hauteur
- Tablette en verre trempé clair
- Peinture époxy
- Colonne largeur 150 mm



Gestion des câbles dans la colonne

2 couleurs disponibles :  
Blanc ou Noir

## Will 1050 L

Ref.	<b>1065375 - Blanc + tablette</b>	GENCOD	318528 039021 2
Ref.	<b>1065376 - Noir + tablette</b>	GENCOD	318528 039031 1

- Réglage de l'écran en hauteur +/- 125 mm
- Réglage en hauteur de la tablette +/- 150 mm
- Socle en acier 6mm
- 6 roulettes multidirectionnelles Ø35 mm

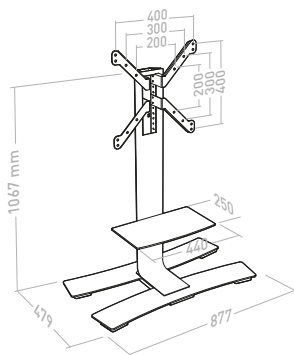

**L** 30"-55"  
76-140 cm



30 KG



VESA  
200x400



ÉPAISSEUR MAXI  
50 mm



## Will 1400 XL

Ref.	<b>1065374 - Blanc + tablette</b>	GENCOD	318528 039041 0
Ref.	<b>1065377 - Noir + tablette</b>	GENCOD	318528 039051 9

- Réglage de l'écran en hauteur +/- 125 mm
- Réglage en hauteur de la tablette +/- 200 mm
- Socle en acier 8mm
- 6 roulettes multidirectionnelles Ø35 mm
- Positionnement écran portrait ou paysage (sauf VESA 600x400)

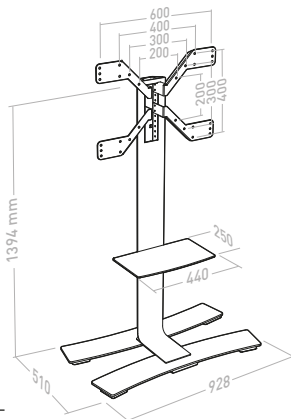

**XL** 40"-75"  
102-190cm



50 KG



VESA  
200x600x400



ÉPAISSEUR MAXI  
80 mm





# STANDiT™

Placer un écran au mur n'a jamais été aussi simple !



- Banc porte périphériques positionnable devant le STANDiT
- Montant en acier 3 mm, peinture époxy noire
- Plateau en verre trempé clair, 6 mm
- Hauteur du banc : 220 mm

## Banc 400

Ref. **1043021**

GENCOD 318528 044700 8



5 KG

- Dimensions utiles du plateau : 600 x 300 mm

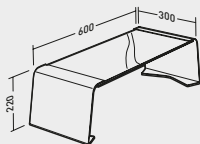

## Banc 600

Ref. **1043020**

GENCOD 318528 044760 2



5 KG

- Dimensions utiles du plateau : 710 x 300 mm

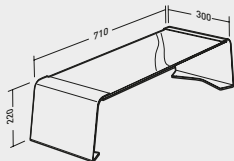

label *l'observateur* **observateur** *du design* <sup>13</sup>



Retrouvez la vidéo du STANDiT™ sur [www.erard-standit.com](http://www.erard-standit.com)

### CARACTÉRISTIQUES TECHNIQUES

- Patin stabilisateur en élastomère repositionnable
- Hauteur d'écran ajustable sur 200 mm (5 positions)
- Système de sécurité anti-décrochement de l'écran
- Structure en acier 5 mm, peinture époxy noire et blanche
- Gestion des câbles au dos
- Livré en 3 parties, montage en 5 minutes avec outil fourni

# STANDiT™ 400

Ref. 1043017

GENCOD 318528 044640 7

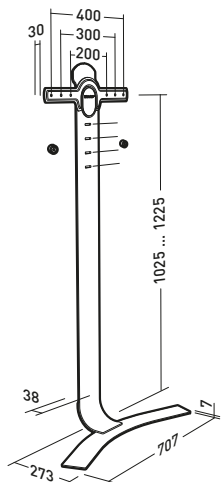

# STANDiT™ 600

Ref. 1043018

GENCOD 318528 044660 5

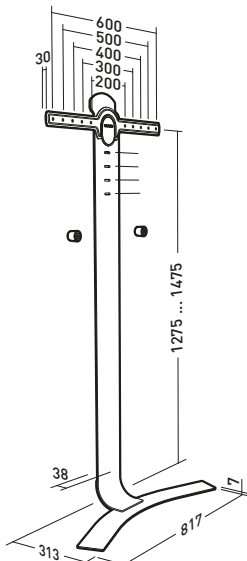

# STANDiT™ PRO

Ref. 1043019

GENCOD 318528 044661 2

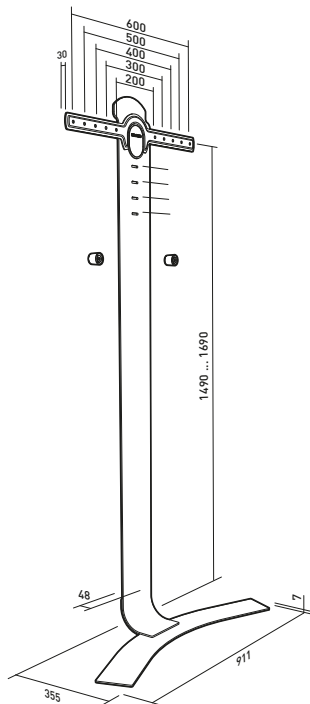

**L** 30"-55"  
76-140 cm



30 KG



VESA  
200 >400



Peignable



ÉPAISSEUR MAXI  
50 mm



**XL** 40"-75"  
102-190cm



45 KG



VESA  
200 >600



Peignable



ÉPAISSEUR MAXI  
60 mm



**XXL** 40"-90"  
102-228cm



45 KG

65 KG si fixation murale



VESA  
200 >600



Peignable



ÉPAISSEUR MAXI  
60 mm  
80 mm si fixation murale



Goulotte de gestion  
des câbles  
et système de sécurité



Standit Pro :  
Livré avec possibilité  
de sécurisation par perçage  
pour lieux publics





# Lux-Up™

Embellissez votre écran !

## CARACTÉRISTIQUES TECHNIQUES

- Réglage de l'écran en hauteur +/- 50 mm
- Possibilité de monter l'écran au format por
- Socle en acier, peinture époxy noire ou blar
- Mât diamètre 60 mm, peinture époxy aspec
- Tête de fixation en acier, peinture époxy noi
- Gestion des câbles incluse dans le mât

## OPTIONS

### Tablette Lux-Up™



Ref. **1043016** GENCOD 318528 038400 6

- Tablette additionnelle porte périphérique
- Positionnable à droite du mât
- Tablette en verre trempé de 6 mm
- Poids maxi 5 kg
- Dimensions utiles : 420 X 240 mm

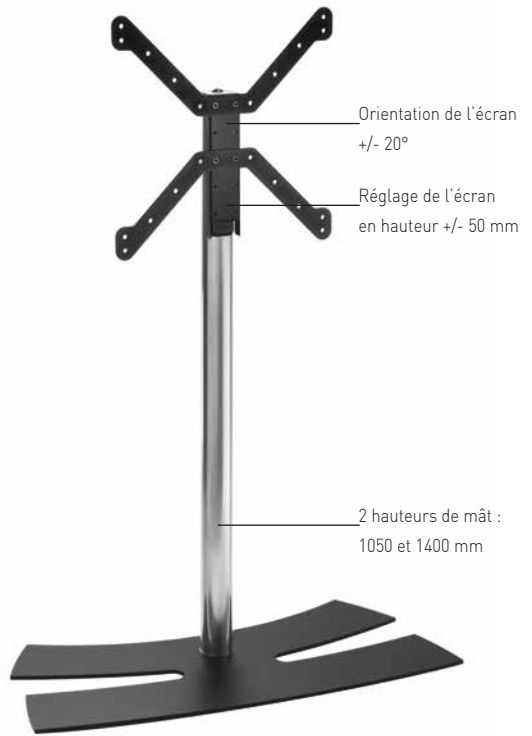

## Lux-Up™ 1050L

Ref. **1043004 - Noir** GENCOD 318528 038142 5

Ref. **1043011 - Blanc** GENCOD 318528 038143 2

- Mât : 1050 mm
- Socle : 865 X 440 mm

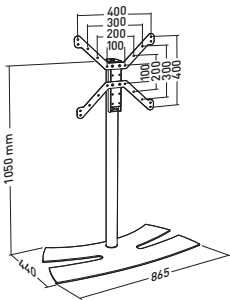

**L 30"-55"**  
76-140 cm



VESA 100x400



+/- 20°



ÉPAISSEUR MAXI 75 mm

## Lux-Up™ 1400L

Ref. **1043012 - Noir** GENCOD 318528 038242 2

Ref. **1043013 - Blanc** GENCOD 318528 038243 9

- Mât : 1400 mm
- Socle : 935 X 480 mm

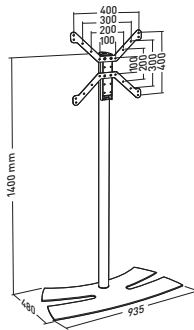

**L 30"-55"**  
76-140 cm



VESA 100x400



+/- 20°



ÉPAISSEUR MAXI 75 mm

## Lux-Up™ 1600XL

Ref. **1043014 - Noir** GENCOD 318528 038442 6

Ref. **1043015 - Blanc** GENCOD 318528 038443 3

- Mât : 1600 mm
- Socle : 1054 X 507 mm

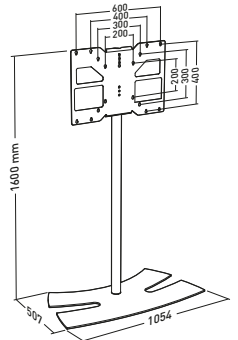

**XL 40"-75"**  
102-190cm



VESA 100x400



+/- 20°



ÉPAISSEUR MAXI 100 mm



## Movik **Big Arm**

Support inclinable et orientable pour écrans de 40" à 90"

Ref. **1043022** GENCOD 318528 047440 0

**XXL** 40"-90"  
102-228cm

- Support mural inclinable - orientable pour écrans de très grande taille et jusqu'à 70 kg
- Structure en acier
- Système anti-collision murale
- Système de manipulation assistée permettant simultanément le déport et l'orientation de l'écran à une seule main (fonction EHF)
- Facile à installer par une seule personne, grâce à une structure en 2 parties livrée montée et à un gabarit de perçage..



70 KG



-18° / +5°



+/- 45°



VESA  
100 >800x545

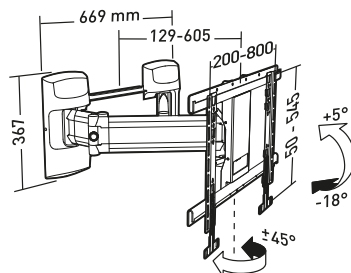
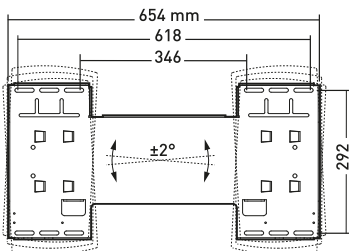



# Kit CURVE

Kit d'adaptation pour écrans à dos courbes ou irréguliers



- 100% compatible avec les supports, colonnes et pieds ERARD
- Compatible avec les principales marques d'écran (SAMSUNG, SONY, PHILIPS, LG...)

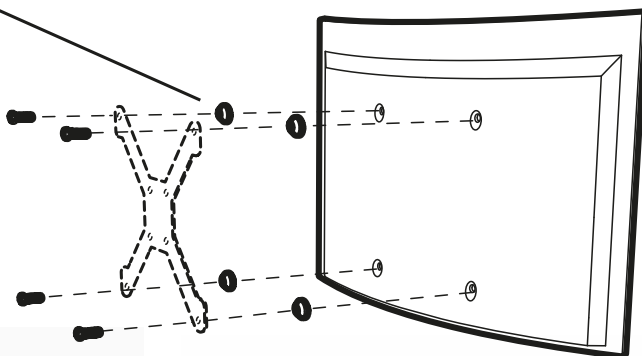

## Kit **CURVE**<sup>+</sup>

Ref. **1043023**

GENCOD 318528 049591 7

# ERARD<sup>®</sup>

ACCESSOIRES **ESSENTIELS**  
POUR MATÉRIELS AUDIO VIDÉO

Mail : [infos@erard.fr](mailto:infos@erard.fr) / [www.erard.com](http://www.erard.com) / Tél : +33 (0)4 72 46 16 26 / Fax : +33 (0)4 72 46 16 22

N° intracommunautaire : FR 19 613 680 073

Z.I. de Chavanoz / 4 route de la Plaine / 38236 PONT DE CHERUY Cedex / FRANCE